

Article number: 12347000100400
Description: KLEE-coil 347 000 100.400
M 10 St. steel 1.4105

Measures

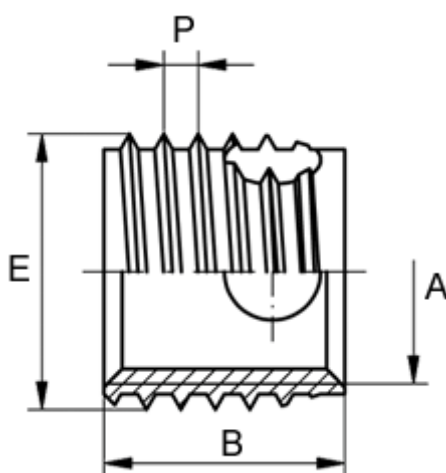

Female thread A	= M10
Length B	= 10
Male thread E	= 12.0
Min hole depth blind hole	= 13
Pre-drilled max	= 11.5
Pre-drilled min	= 11.2
Thread pitch P	= 1.50
Type	= 347 000 100 ...